



# 4-Channel Ultra High Efficiency Quad-Mode® LED Driver with 32 Dimming Levels



## FEATURES

- High efficiency 1.33x charge pump
- Quad-mode charge pump: 1x, 1.33x, 1.5x, 2x
- Drives up to 4 LEDs at 25mA each
- 1-wire EZDim™ 32 linear steps
- Power efficiency up to 92%
- Low noise input ripple in all modes
- “Zero” current shutdown mode
- Soft start and current limiting
- Short circuit protection
- Thermal shutdown protection
- 3mm x 3mm, 16-pad TQFN package

## APPLICATION

- LCD Display Backlight
- Cellular Phones
- Digital Still Cameras
- Handheld Devices

## ORDERING INFORMATION

Part Number	Qty per Reel	Marking
CAT3648HV3-GT2	2000 <sup>(1)</sup>	JAAN

Notes: (1) NiPdAu Plated Finish (RoHS-compliant)

## PIN CONFIGURATION

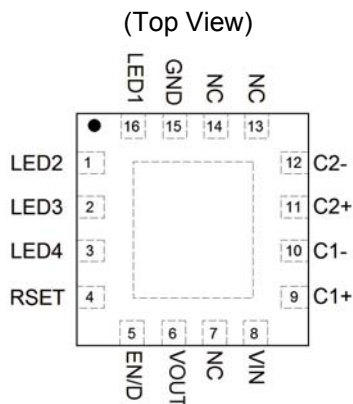

## DESCRIPTION

The CAT3648 is a high efficiency quad-mode fractional charge pump that can drive up to four LEDs programmable by a one wire digital interface. The inclusion of a 1.33x fractional charge pump mode increases device efficiency by up to 10% over traditional 1.5x charge pumps with no added external capacitors.

Low noise input ripple is achieved by operating at a constant switching frequency which allows the use of small external ceramic capacitors. The multi-fractional charge pump supports a wide range of input voltages from 2.5V to 5.5V.

The EN/DIM logic input functions as a chip enable and a digital dimming interface for setting the current in all LED channels. The 1-wire pulse-dimming interface supports 32 linear steps from full-scale down to zero current.

The device is available in the tiny 16-pad TQFN 3mm x 3mm package with a max height of 0.8mm.

Catalyst Semiconductor's Quad-Mode® 1.33x, charge pump switching architecture is patented.

## TYPICAL APPLICATION CIRCUIT

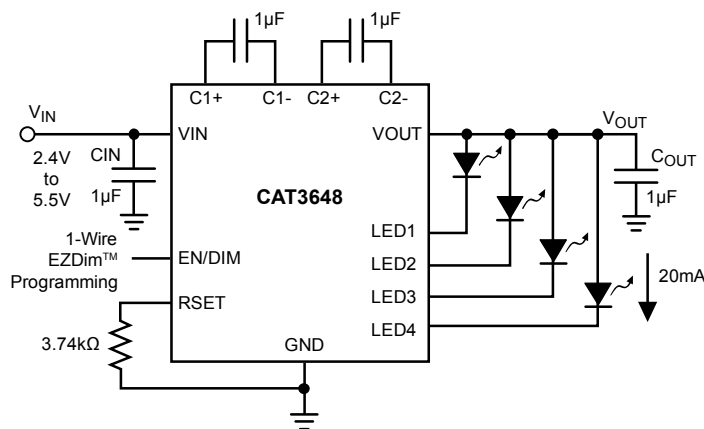

**ABSOLUTE MAXIMUM RATINGS**

Parameter	Rating	Unit
V <sub>IN</sub> , LED <sub>x</sub> , C1±, C2±, EN/DIM voltage	6	V
V <sub>OUT</sub> voltage	7	V
Storage Temperature Range	-65 to +160	°C
Junction Temperature Range	-40 to +150	°C

**RECOMMENDED OPERATING CONDITIONS**

Parameter	Rating	Unit
V <sub>IN</sub>	2.5 to 5.5	V
Ambient Temperature Range	-40 to +85	°C
I <sub>LED</sub> per LED pin	up to 30	mA
LED Forward Voltage Range	1.3 to 4.3	V

Typical application circuit with external components is shown on page 1.

**ELECTRICAL OPERATING CHARACTERISTICS**

(over recommended operating conditions unless specified otherwise) V<sub>IN</sub> = 3.6V, EN = High, T<sub>AMB</sub> = 25°C

Symbol	Name	Conditions	Min	Typ	Max	Units
I <sub>Q</sub>	Quiescent Current	1x mode, excluding load 1.33x mode, excluding load 1.5x mode, excluding load 2x mode, excluding load		1.0 1.7 2.2 2.4		mA mA mA mA
I <sub>QSHDN</sub>	Shutdown Current	V <sub>EN</sub> = 0V			1	µA
I <sub>LED-ACC</sub>	LED Current Setting	RSET = 3.74kΩ RSET = 7.50kΩ		20 10		mA
I <sub>LED-ACC</sub>	LED Current Accuracy	(I <sub>LEDAVG</sub> - I <sub>NOMINAL</sub> ) / I <sub>NOMINAL</sub> RSET = 4.99kΩ		±2		%
I <sub>LED-DEV</sub>	LED Channel Matching	(I <sub>LED</sub> - I <sub>LEDAVG</sub> ) / I <sub>LEDAVG</sub>		±1.5		%
V <sub>RSET</sub>	RSET Regulated Voltage		0.58	0.6	0.62	V
R <sub>OUT</sub>	Output Resistance (open loop)	1x mode 1.33x mode, V <sub>IN</sub> = 3V 1.5x mode, V <sub>IN</sub> = 2.7V 2x mode, V <sub>IN</sub> = 2.4V		0.8 5 5 10		Ω Ω Ω Ω
F <sub>OSC</sub>	Charge Pump Frequency	1.33x and 2x mode 1.5x mode	0.8 1	1 1.3	1.3 1.6	MHz MHz
I <sub>SC_MAX</sub>	Output short circuit Current Limit	V <sub>OUT</sub> < 0.5V		50		mA
I <sub>IN_MAX</sub>	Input Current Limit	V <sub>OUT</sub> > 1V, 1x mode		250		mA
LED <sub>TH</sub>	1x to 1.33x or 1.33x to 1.5x or 1.5x to 2x Transition Thresholds at any LED pin			130		mV
V <sub>HYS</sub>	1x Mode Transition Hysteresis			400		mV
T <sub>DF</sub>	Mode Transition Filter Delay			120		µs
R <sub>EN/DIM</sub> V <sub>HI</sub> V <sub>LO</sub>	EN/DIM Pin • Internal Pull-down Resistor • Logic High Level • Logic Low Level		1.3	100	0.4	kΩ V V
T <sub>SD</sub>	Thermal Shutdown			150		°C
T <sub>HYS</sub>	Thermal Hysteresis			20		°C
V <sub>UVLO</sub>	Undervoltage lockout (UVLO) threshold		1.6	1.8	2.0	V

**RECOMMENDED EN/DIM TIMING**

For  $2.4V \leq V_{IN} \leq 5.5V$ , over full ambient temperature range  $-40^{\circ}C$  to  $+85^{\circ}C$ .

Symbol	Name	Conditions	Min	Typ	Max	Units
$T_{LO}$	EN/DIM program low time		0.2		100	$\mu s$
$T_{HI}$	EN/DIM program high time		0.2			$\mu s$
$T_{PWRDWN}$	EN/DIM low time to shutdown		1.5			ms
$T_{LED}$	LED current settling time			40		$\mu s$

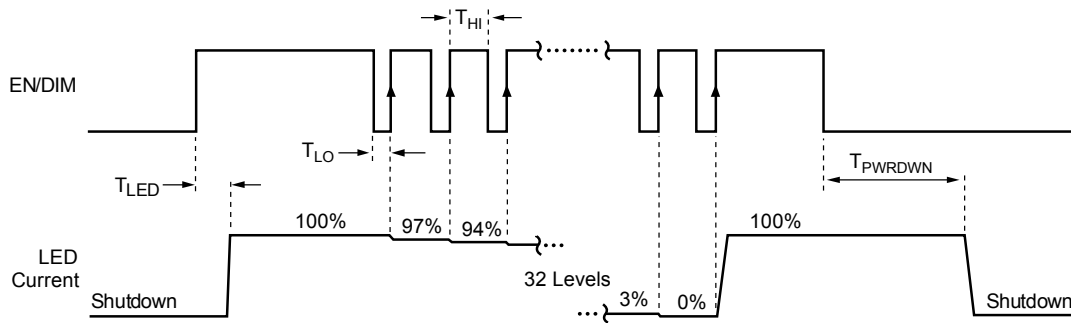

**Figure 1. EN/DIM Digital Dimming Timing Diagram**

**LED Current Setting**

The full scale LED current is set by the external resistor connected between the RSET pin and ground. Table 1 lists standard resistor values for several LED current settings.

**Table 1. Resistor RSET and LED Current**

Full Scale LED Current [mA]	RSET [k $\Omega$ ]
2	37.4
5	14.7
10	7.50
15	4.99
20	3.74
25	3.00
30	2.49

**TYPICAL PERFORMANCE CHARACTERISTICS**

$V_{IN} = 3.6V$ ,  $I_{OUT} = 80mA$  (4 LEDs at 20mA),  $C_{IN} = C_{OUT} = C_1 = C_2 = 1\mu F$ ,  $T_{AMB} = 25^\circ C$  unless otherwise specified.

**Efficiency vs. Input Voltage**

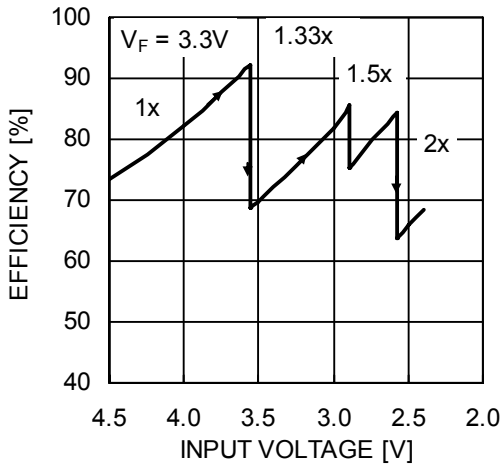

**Efficiency vs. Li-Ion Voltage**

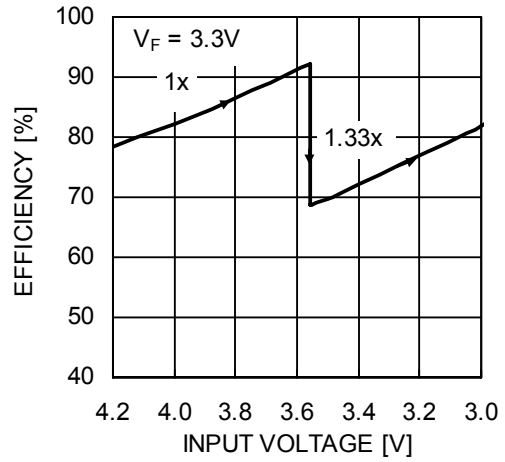

**Quiescent Current vs. Input Voltage**

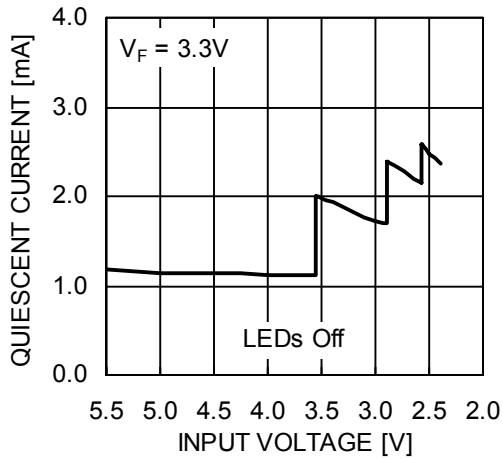

**Quiescent Current vs. Temperature**

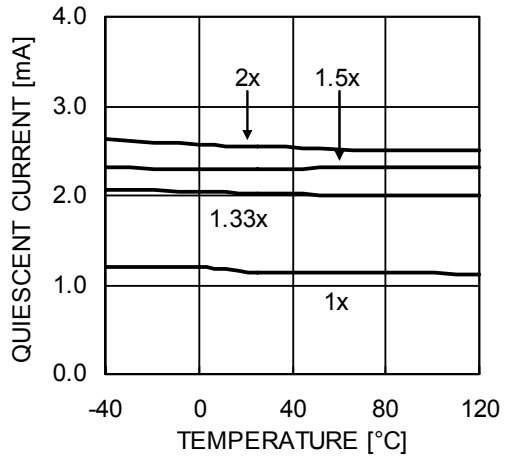

**LED Current Change vs. Input Voltage**

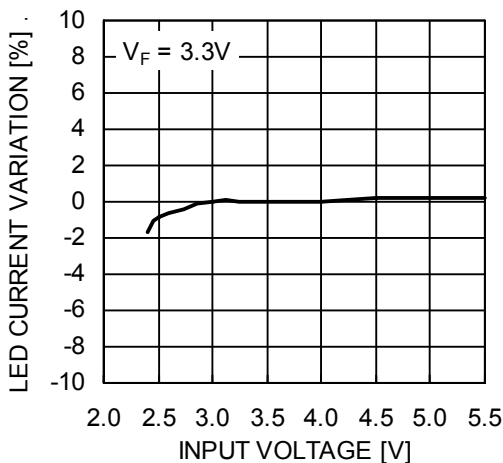

**LED Current Change vs. Temperature**

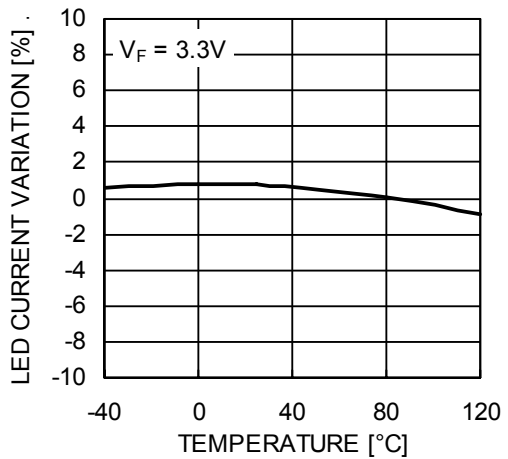

**TYPICAL PERFORMANCE CHARACTERISTICS**

$V_{IN} = 3.6V$ ,  $I_{OUT} = 80mA$  (4 LEDs at 20mA),  $C_{IN} = C_{OUT} = C_1 = C_2 = 1\mu F$ ,  $T_{AMB} = 25^{\circ}C$  unless otherwise specified.

**Switching Frequency vs. Temperature**

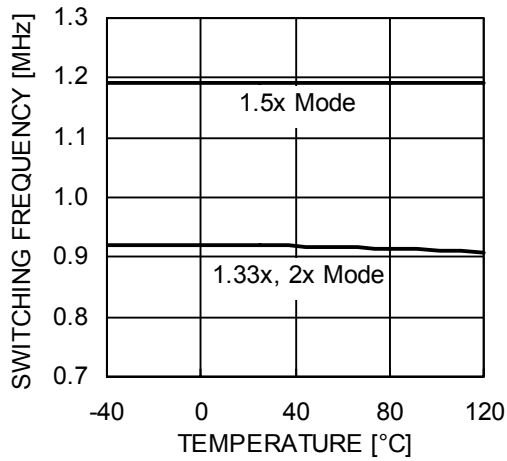

**Output Resistance vs. Input Voltage**

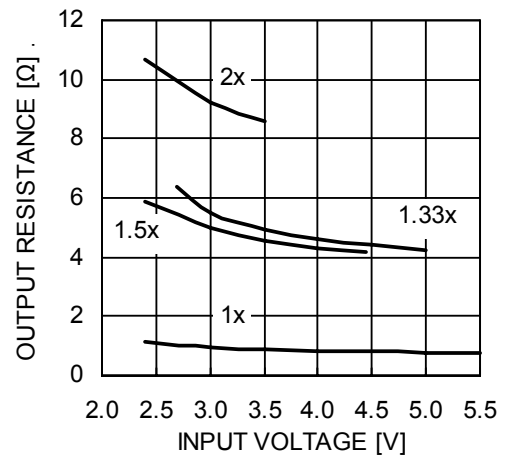

**Power Up in 1x Mode**

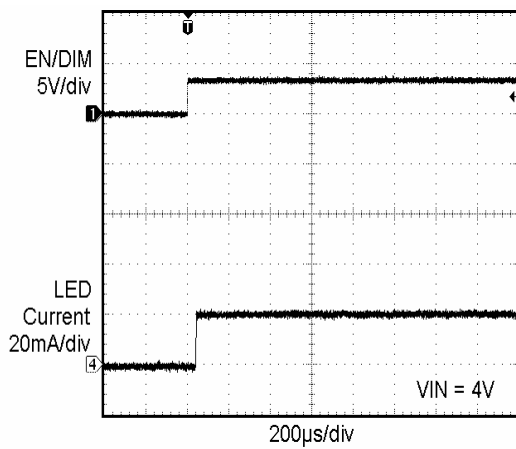

**Power Up in 1.33x Mode**

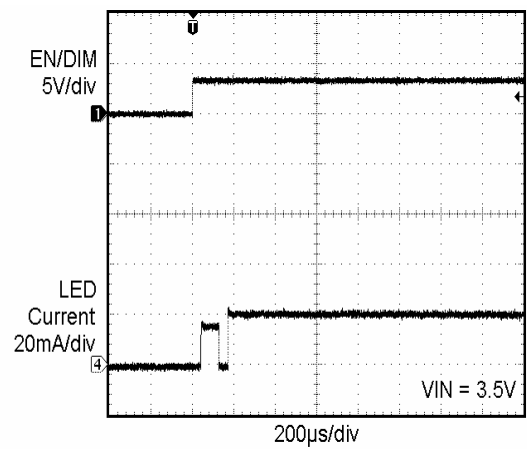

**Power Up in 1.5x Mode**

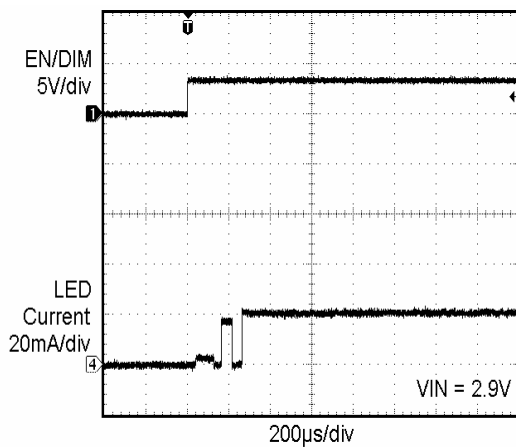

**Power Up in 2x Mode**

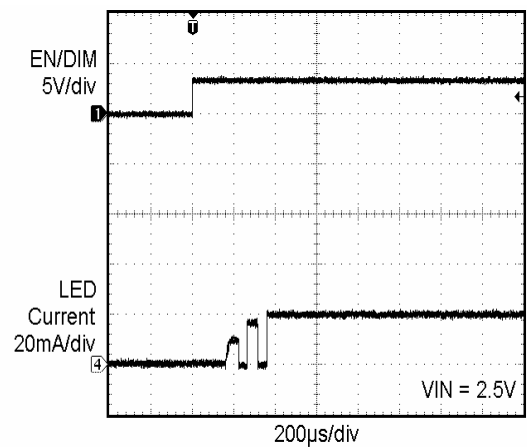

**TYPICAL PERFORMANCE CHARACTERISTICS**

$V_{IN} = 3.6V$ ,  $I_{OUT} = 80mA$  (4 LEDs at 20mA),  $C_{IN} = C_{OUT} = C_1 = C_2 = 1\mu F$ ,  $T_{AMB} = 25^{\circ}C$  unless otherwise specified.

**Power Up Delay (1x Mode)**

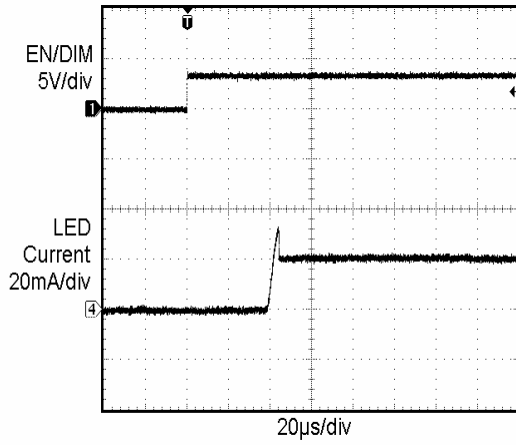

**Power Down Delay (1x Mode)**

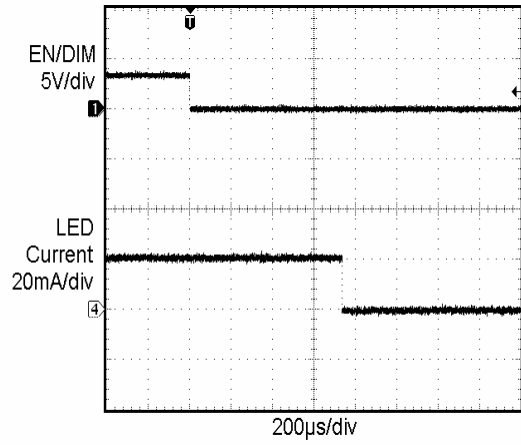

**Operating Waveforms in 1x Mode**

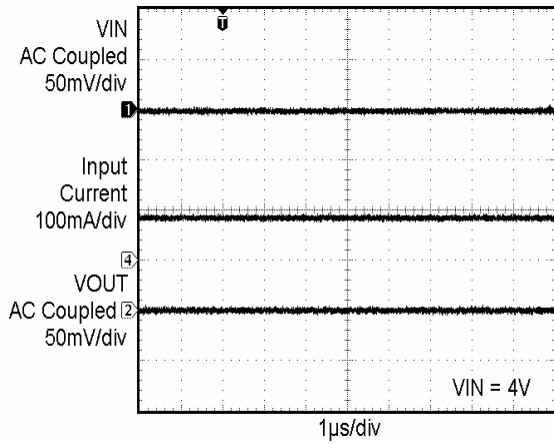

**Switching Waveforms in 1.33x Mode**

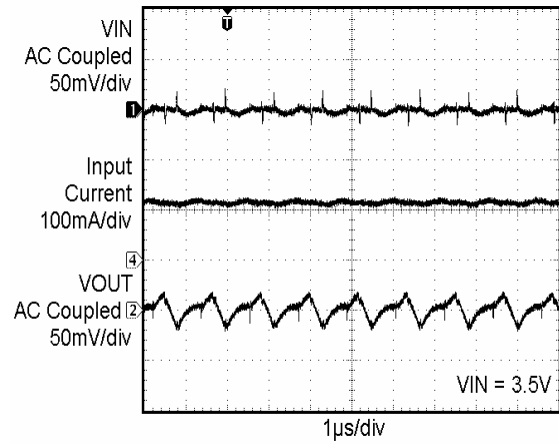

**Switching Waveforms in 1.5x Mode**

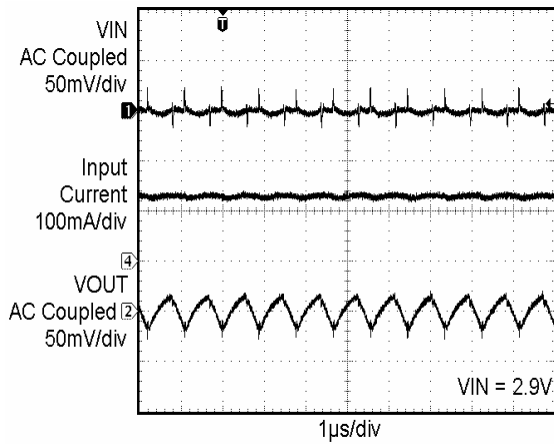

**Switching Waveforms in 2x Mode**

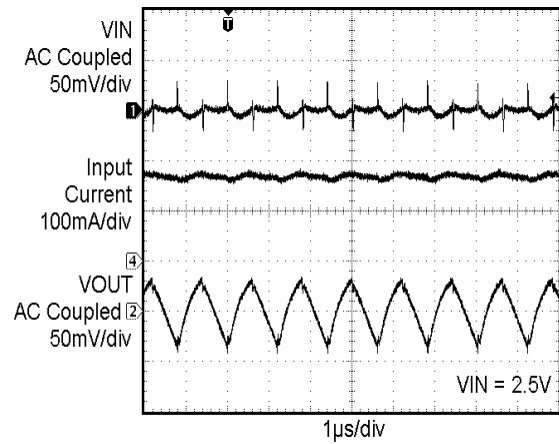

**TYPICAL PERFORMANCE CHARACTERISTICS**

$V_{IN} = 3.6V$ ,  $I_{OUT} = 80mA$  (4 LEDs at 20mA),  $C_{IN} = C_{OUT} = C_1 = C_2 = 1\mu F$ ,  $T_{AMB} = 25^\circ C$  unless otherwise specified.

**Foldback Current Limit**

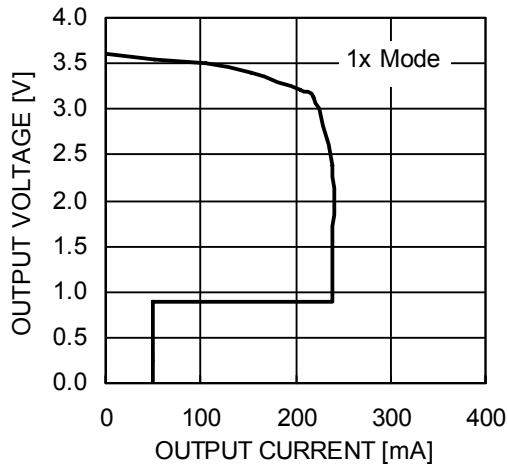

**LED Current vs. LED Pin Voltage**

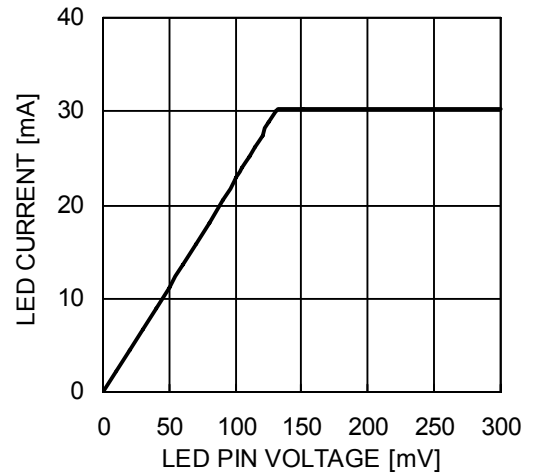

**Dimming Waveform**

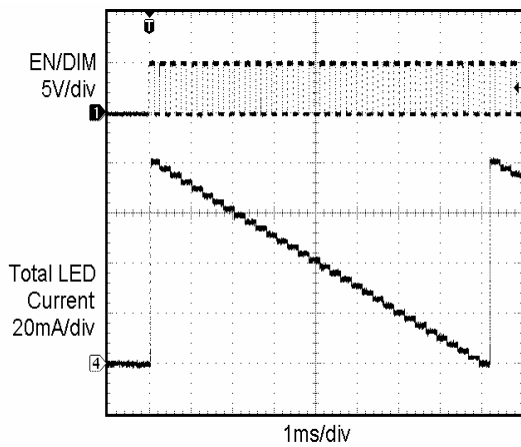

**PIN DESCRIPTION**

Pin #	Name	Function
1	LED2	LED2 cathode terminal.
2	LED3	LED3 cathode terminal.
3	LED4	LED4 cathode terminal.
4	RSET	Connect resistor RSET to set the LED current.
5	EN/DIM	Device enable (active high) and Dimming Control.
6	VOUT	Charge pump output connected to the LED anodes.
7	NC	Not connected inside the package.
8	VIN	Charge pump input, connect to battery or supply.
9	C1+	Bucket capacitor 1 Positive terminal
10	C1-	Bucket capacitor 1 Negative terminal
11	C2+	Bucket capacitor 2 Positive terminal
12	C2-	Bucket capacitor 2 Negative terminal
13	NC	Not connected inside the package.
14	NC	Not connected inside the package.
15	GND	Ground Reference
16	LED1	LED1 cathode terminal.
TAB	GND	Connect to GND on the PCB.

**PIN FUNCTION**

**VIN** is the supply pin for the charge pump. A small 1µF ceramic bypass capacitor is required between the VIN pin and ground near the device. The operating input voltage range is from 2.5V to 5.5V. Whenever the input supply falls below the under-voltage threshold (1.8V), all the LED channels are disabled and the device enters shutdown mode.

**EN/DIM** is the enable and one wire dimming input for all LED channels. Levels of logic high and logic low are set at 1.3V and 0.4V respectively. When EN/DIM is initially taken high, the device becomes enabled and all LED currents are set to the full scale according to the resistor R<sub>SET</sub>. To place the device into “zero current” shutdown mode, the EN/DIM pin must be held low for at least 1.5ms.

**VOUT** is the charge pump output that is connected to the LED anodes. A small 1µF ceramic bypass capacitor is required between the V<sub>OUT</sub> pin and ground near the device.

**GND** is the ground reference for the charge pump. The pin must be connected to the ground plane on the PCB.

**C1+, C1-** are connected to each side of the ceramic bucket capacitor C<sub>1</sub>.

**C2+, C2-** are connected to each side of the ceramic bucket capacitor C<sub>2</sub>.

**LED1 to LED4** provide the internal regulated current source for each of the LED cathodes. These pins enter high-impedance zero current state whenever the device is placed in shutdown mode.

**TAB** is the exposed pad underneath the package. For best thermal performance, the tab should be soldered to the PCB and connected to the ground plane.

**RSET** is connected to the resistor (R<sub>SET</sub>) to set the full scale current for the LEDs. The voltage at this pin regulated to 0.6V. The ground side of the external resistor should be star connected back to the GND of the PCB. In shutdown mode, RSET becomes high impedance.



## BLOCK DIAGRAM

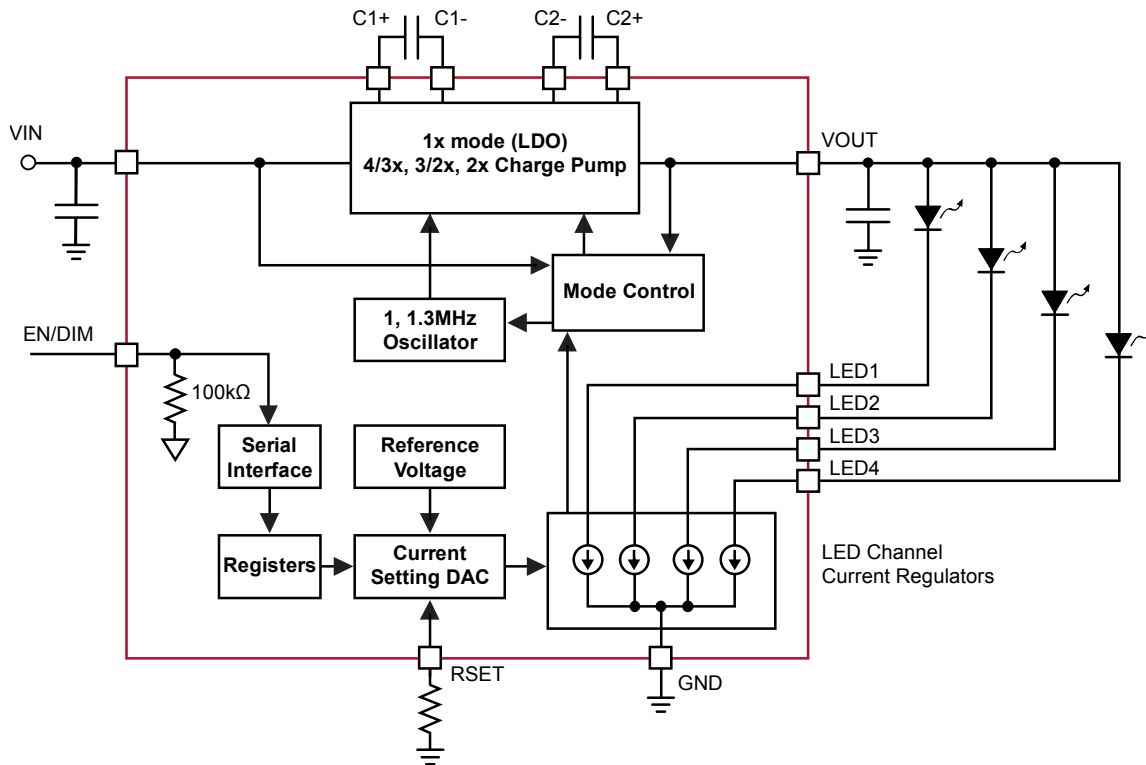

Figure 2. CAT3648 Functional Block Diagram

## BASIC OPERATION

At power-up, the CAT3648 starts operating in 1x mode where the output will be approximately equal to the input supply voltage (less any internal voltage losses). If the output voltage is sufficient to regulate all LED currents, the device remains in 1x operating mode.

If the input voltage is insufficient or falls to a level where the regulated currents cannot be maintained, the device automatically switches into 1.33x mode (after a fixed delay time of about 120 $\mu$ s). In 1.33x mode, the output voltage is approximately equal to 1.33 times the input supply voltage (less any internal voltage losses).

This sequence repeats in the 1.33x and 1.5x mode until the driver enters the 2x mode. In 1.5x mode, the output voltage is approximately equal to 1.5 times the input supply voltage. While in 2x mode, the output is approximately equal to 2 times the input supply voltage.

If the device detects a sufficient input voltage is present to drive all LED currents in 1x mode, it will change automatically back to 1x mode. This only applies for changing back to the 1x mode. The difference between the input voltage when exiting 1x mode and returning to 1x mode is called the 1x mode transition hysteresis ( $V_{HYS}$ ) and is about 400mV.

**LED Current Selection**

After power-up, the LED current is set by the external resistor ( $R_{SET}$ ) value and the number of pulses (n) on the EN/DIM input as follows:

$$\text{LED current} = 125 \times \frac{0.6V}{R_{SET}} \times \left( \frac{31-n}{31} \right)$$

The full scale current is calculated from the above formula with n equal to zero.

The EN/DIM pin has two primary functions. One function enables and disables the device. The other function is LED current dimming with 32 different levels by pulsing the input signal, as shown on Figure 3. On each consecutive pulse rising edge, the LED current is decreased by about 3.2% (1/31<sup>th</sup> of the full scale value). After 30 pulses, the LED current is 3.2% of the full scale current. On the 31<sup>st</sup> pulse, the current drops to zero, and then goes back to full scale on the following pulse.

Each pulse width should be between 200ns and 100µs. Pulses faster than the minimum  $T_{LO}$  may be ignored and filtered by the device. Pulses longer than the maximum  $T_{LO}$  may shutdown the device. By pulsing the EN/DIM signal at high frequency, the LED current can quickly be set to zero.

The LED driver enters a “zero current” shutdown mode if EN/DIM is held low for 1.5ms or more.

The dimming level is set by the number of pulses on the EN/DIM after the power-up, as shown in Table 2.

**Table 2. Dimming Levels**

Full Scale Current in %	Dimming Pulses [n]
100	0
97	1
94	2
90	3
87	4
84	5
81	6
77	7
74	8
71	9
68	10
65	11
61	12
58	13
55	14
52	15
48	16
45	17
42	18
39	19
35	20
32	21
29	22
26	23
23	24
19	25
16	26
13	27
10	28
6	29
3	30
0	31
100	32

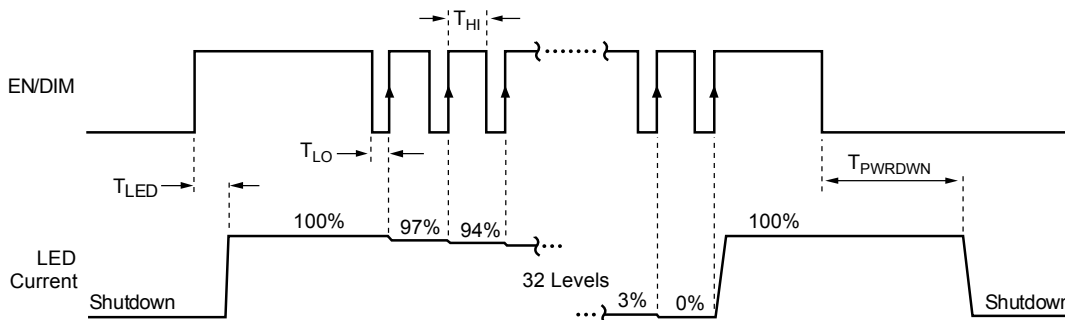

**Figure 3. EN/DIM Digital Dimming Timing Diagram**

**Unused LED Channels**

For applications not requiring all the channels, it is recommended the unused LED pins be tied directly to VOUT (see Figure 4).

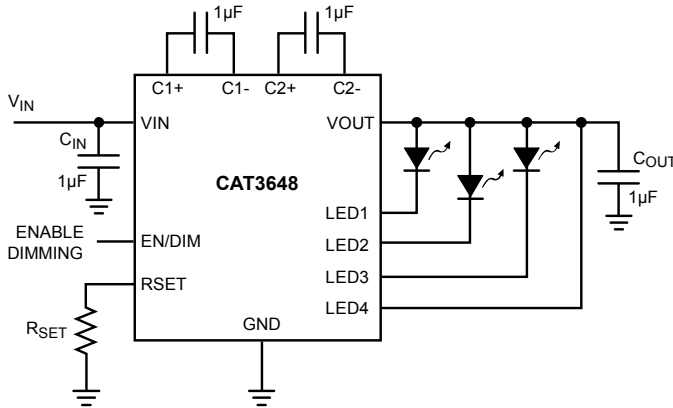

**Figure 4. Application with 3 LEDs**

**Protection Mode**

If an LED is disconnected, the driver senses that and automatically ignores that channel. When all LEDs are disconnected, the driver goes to 1x mode where the output is equal to the input voltage.

As soon as the output exceeds about 6V, the driver resets itself and re-evaluates the mode.

If the die temperature exceeds +150°C, the driver will enter a thermal protection shutdown mode. When the device temperature drops by about 20°C, the device will resume normal operation.

**LED Selection**

LEDs with forward voltages ( $V_F$ ) ranging from 1.3V to 4.3V may be used. Selecting LEDs with lower  $V_F$  is recommended in order to improve the efficiency by keeping the driver in 1x mode longer as the battery voltage decreases.

For example, if a white LED with a  $V_F$  of 3.3V is selected over one with  $V_F$  of 3.5V, the driver will stay in 1x mode for lower supply voltage of 0.2V. This helps improve the efficiency and extends battery life.

**External Components**

The driver requires four external 1µF ceramic capacitors for decoupling input, output, and for the charge pump. Both capacitors type X5R and X7R are recommended for the LED driver application. In all charge pump modes, the input current ripple is kept very low by design and an input bypass capacitor of 1µF is sufficient.

In 1x mode, the device operates in linear mode and does not introduce switching noise back onto the supply.

**Recommended Layout**

In charge pump mode, the driver switches internally at a high frequency. It is recommended to minimize trace length to all four capacitors. A ground plane should cover the area under the driver IC as well as the bypass capacitors. Short connection to ground on capacitors  $C_{IN}$  and  $C_{OUT}$  can be implemented with the use of multiple via. A copper area matching the TQFN exposed pad (TAB) must be connected to the ground plane underneath. The use of multiple via improves the package heat dissipation.

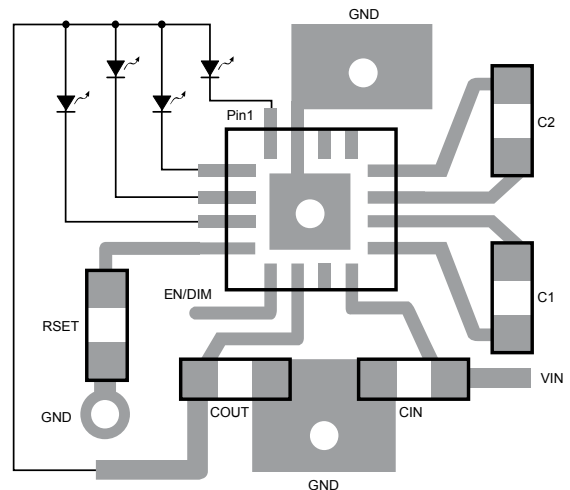

**Figure 5. Recommended Layout**

PACKAGE OUTLINE DRAWING

TQFN 16-Pad 3 x 3mm (HS3, HV3) <sup>(1)(2)</sup>

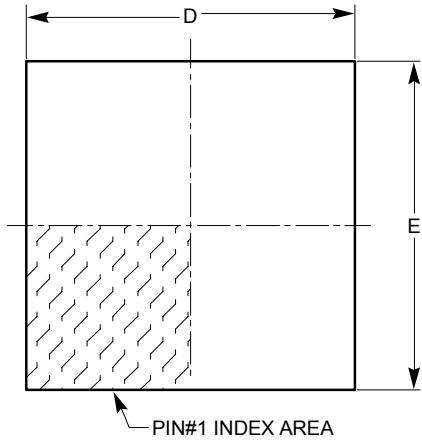

TOP VIEW

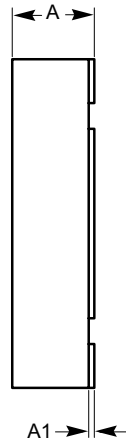

SIDE VIEW

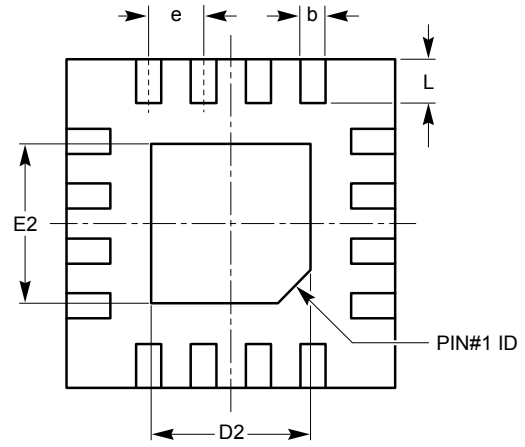

BOTTOM VIEW

SYMBOL	MIN	NOM	MAX
A	0.70	0.75	0.80
A1	0.00	0.02	0.05
A3	0.20 REF		
b	0.18	0.25	0.30
D	2.90	3.00	3.10
D2	1.40	-	1.80
E	2.90	3.00	3.10
E2	1.40	-	1.80
e	0.50 BSC		
L	0.30	0.40	0.50

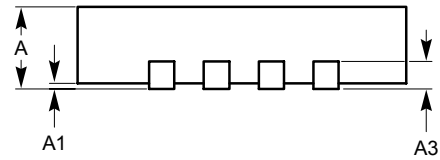

FRONT VIEW

Notes:

- (1) All dimensions are in millimeters.
- (2) Complies with JEDEC standard MO-220.

EXAMPLE OF ORDERING INFORMATION <sup>(1)(2)</sup>

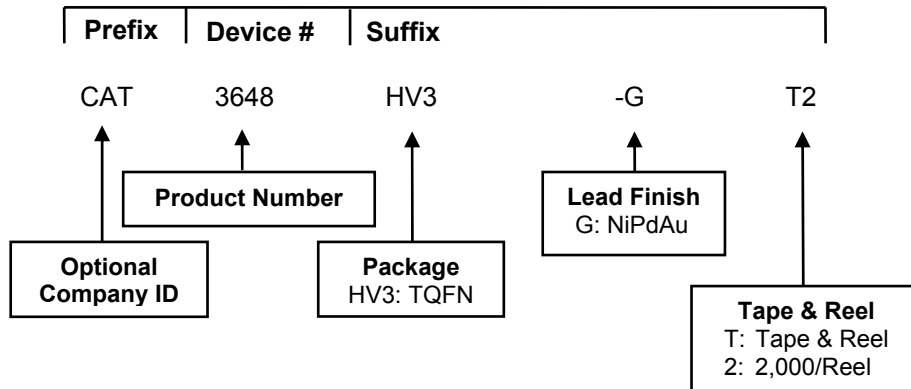

**Notes:**

- (1) All packages are RoHS-compliant (Lead-free, Halogen-free).
- (2) The standard lead finish is NiPdAu.
- (3) The device used in the above example is a CAT3648HV3-GT2 (TQFN, NiPdAu, Tape & Reel, 2,000/Reel).
- (4) For additional package and temperature options, please contact your nearest ON Semiconductor Sales office.

**REVISION HISTORY**

Date	Revision	Description
02-Apr-08	A	Initial Release
07-Aug-08	B	Changed "Quad-Mode™" to "Quad-Mode®"
17-Nov-08	C	Change logo and fine print to ON Semiconductor

ON Semiconductor and  are registered trademarks of Semiconductor Components Industries, LLC (SCILLC). SCILLC reserves the right to make changes without further notice to any products herein. SCILLC makes no warranty, representation or guarantee regarding the suitability of its products for any particular purpose, nor does SCILLC assume any liability arising out of the application or use of any product or circuit, and specifically disclaims any and all liability, including without limitation special, consequential or incidental damages. "Typical" parameters which may be provided in SCILLC data sheets and/or specifications can and do vary in different applications and actual performance may vary over time. All operating parameters, including "Typicals" must be validated for each customer application by customer's technical experts. SCILLC does not convey any license under its patent rights nor the rights of others. SCILLC products are not designed, intended, or authorized for use as components in systems intended for surgical implant into the body, or other applications intended to support or sustain life, or for any other application in which the failure of the SCILLC product could create a situation where personal injury or death may occur. Should Buyer purchase or use SCILLC products for any such unintended or unauthorized application, Buyer shall indemnify and hold SCILLC and its officers, employees, subsidiaries, affiliates, and distributors harmless against all claims, costs, damages, and expenses, and reasonable attorney fees arising out of, directly or indirectly, any claim of personal injury or death associated with such unintended or unauthorized use, even if such claim alleges that SCILLC was negligent regarding the design or manufacture of the part. SCILLC is an Equal Opportunity/Affirmative Action Employer. This literature is subject to all applicable copyright laws and is not for resale in any manner.

**PUBLICATION ORDERING INFORMATION**

**LITERATURE FULFILLMENT:**

**Literature Distribution Center for ON Semiconductor**  
 P.O. Box 5163, Denver, Colorado 80217 USA  
**Phone:** 303-675-2175 or 800-344-3860 Toll Free USA/Canada  
**Fax:** 303-675-2176 or 800-344-3867 Toll Free USA/Canada  
**Email:** [orderlit@onsemi.com](mailto:orderlit@onsemi.com)

**N. American Technical Support:** 800-282-9855 Toll Free  
 USA/Canada  
**Europe, Middle East and Africa Technical Support:**  
 Phone: 421 33 790 2910  
**Japan Customer Focus Center:**  
 Phone: 81-3-5773-3850

**ON Semiconductor Website:** [www.onsemi.com](http://www.onsemi.com)  
**Order Literature:** <http://www.onsemi.com/orderlit>  
 For additional information, please contact your local Sales Representative